



SOT-89 Package

General Description

The TQP369180 is a general-purpose buffer amplifier that offers high dynamic range in a low-cost surface-mount package. At 1.9 GHz, the amplifier typically provides 15.0 dB gain, +29.5 dBm OIP3, and 3.6 dB Noise Figure while drawing 45 mA current. The device combines dependable performance with consistent quality to maintain MTTF values exceeding 100 years at mounting temperatures of +85°C. The device is housed in a lead-free/green/RoHS-compliant industry-standard SOT-89 package.

The TQP369180 consists of a Darlington-pair amplifier using the high reliability InGaP/GaAs HBT process technology. Only DC-blocking capacitors, a bias resistor, and an inductive RF choke are required for operation.

This broadband MMIC amplifier can be directly applied to various current and next generation wireless technologies such as CDMA, W-CDMA, and LTE. In addition, the TQP369180 will work for other applications within the DC to 6 GHz frequency range.

Functional Block Diagram

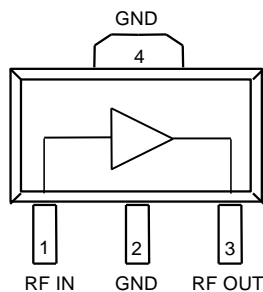

Product Features

- DC-6000 MHz
- Flat, broadband frequency response
- 15 dB Gain at 1.9 GHz
- 3.6 dB Noise Figure at 1.9 GHz
- +29.5 dBm Output IP3 at 1.9 GHz
- +14.4 dBm P1dB at 1.9 GHz
- 50 Ohm Cascadable Gain Block
- Single Supply, 45 mA Current
- SOT-89 Package

Applications

- Wireless Infrastructure
- CATV / SATV / MoCA
- Point to Point
- Defense & Aerospace
- Test & Measurement Equipment
- General Purpose Wireless

Ordering Information

Part No.	Description
TQP369180	InGaP/GaAs HBT Gain Block
TQP369180-PCB	0.5-4 GHz Evaluation Board

Standard T/R size = 2500 pieces on a 13" reel



TQP369180

DC – 6 GHz Gain Block

Absolute Maximum Ratings

Parameter	Rating
Storage Temperature	-55 to 150°C
RF Input Power, CW, 50Ω, T=25°C	+27 dBm
Device Voltage (V _{CC})	+5.2 V

Operation of this device outside the parameter ranges given above may cause permanent damage.

Recommended Operating Conditions

Parameter	Min	Typ	Max	Units
T _{CASE}	-40		+85	°C
T _j for >10 ⁶ hours MTTF			+170	°C

Electrical specifications are measured at specified test conditions. Specifications are not guaranteed over all recommended operating conditions.

Electrical Specifications

Test conditions unless otherwise noted: I_{CC} =45 mA, T_{CASE}= +25°C, 50Ω system

Parameter	Conditions	Min	Typ	Max	Units
Operational Frequency Range		DC		6000	MHz
Test Frequency			1900		MHz
Gain		13.5	15.0	16.5	dB
Input Return Loss			20.1		dB
Output Return Loss			17.8		dB
Output P1dB			+14.4		dBm
Output IP3	P _{out} =0 dBm/tone, Δf= 1 MHz	+26.0	+29.5		dBm
Noise Figure			3.6		dB
Device Voltage (V _{CC})		3.0	3.9	4.5	V
Device Current, (I _{CC})			45		mA
Thermal Resistance, (θ _{JC})	Junction to case ⁽¹⁾			128	°C/W

Notes:

1. Thermal path is from the device junction through the package ground tab (pins 2 & 4) to the backside mounting surface.



TQP369180

DC – 6 GHz Gain Block

S-Parameters

Test Conditions: $V_{CC}=+3.9$ V (typ.), $I_{CC}=45$ mA (typ.), $T_{CASE}=+25^{\circ}\text{C}$, 50Ω system, calibrated to device leads

Freq (MHz)	S11 (dB)	S11 (ang)	S21 (dB)	S21 (ang)	S12 (dB)	S12 (ang)	S22 (dB)	S22 (ang)
10	-28.1	-178.4	16.1	179.8	-19.0	0.5	-38.9	46.0
20	-27.6	-176.2	16.1	179.4	-19.0	-0.2	-40.4	34.7
50	-27.4	-178.9	16.1	178.9	-18.9	-0.7	-40.9	0.7
100	-27.1	176.6	16.1	176.5	-18.9	-1.6	-44.0	4.6
200	-27.5	175.7	16.1	172.9	-18.9	-3.3	-40.9	13.8
500	-28.4	151.7	16.1	162.9	-19.0	-8.4	-45.8	-66.1
900	-26.4	148.6	15.9	149.1	-19.0	-15.6	-42.0	-131.5
1000	-25.9	139.6	15.9	145.6	-19.0	-17.2	-36.4	-158.2
1500	-24.2	135.2	15.8	128.4	-19.1	-25.8	-28.6	176.7
1900	-22.8	116.2	15.7	114.9	-19.1	-32.9	-24.4	164.8
2000	-21.5	109.8	15.7	111.7	-19.2	-34.9	-23.9	168.4
2500	-19.3	104.3	15.6	94.6	-19.3	-42.8	-20.6	139.2
3000	-18.6	93.7	15.4	78.3	-19.5	-51.7	-17.4	130.9
3500	-18.1	76.1	15.2	61.8	-19.8	-61.0	-16.2	125.1
4000	-16.4	76.9	15.1	44.9	-19.9	-68.8	-14.4	109.0
4500	-15.7	65.7	14.8	28.2	-20.3	-78.5	-13.3	99.6
5000	-16.2	67.4	14.6	11.9	-20.4	-86.8	-12.9	91.7
5500	-17.6	62.5	14.5	-5.0	-21.0	-94.9	-11.6	85.0
6000	-15.9	53.6	14.2	-21.7	-21.5	-103.1	-11.1	82.5

TQP369180-PCB Evaluation Board

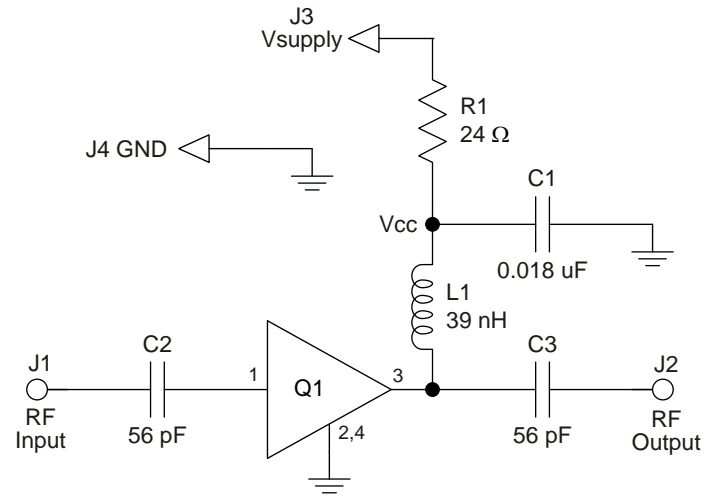
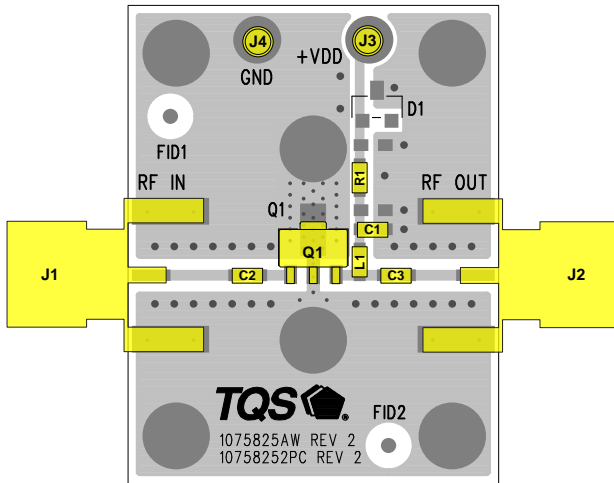

Notes:

1. See Evaluation Board PCB Information section for material and stack-up.
2. All components are of 0603 size unless otherwise stated.

Bill of Material – TQP369180-PCB

Reference Des.	Value	Description	Manuf.	Part Number
Q1	n/a	High Linearity LNA Gain Block	Qorvo	TQP369180
C1	0.018 uF	Cap, Chip, 0603, 16V, X7R, 10%	various	
C2, C3	56 pF	Cap, Chip, 0603, 50V, NPO, 5%	various	
L1	39 nH	Inductor, 0603, 5%, CS Series	Coilcraft	0603CS-39NXJL
R1	24 Ω	Res, Chip, 0805, 1/10W, 5%	various	

Component Values for Specific Frequencies

Frequency (MHz)	50	500	900	1900	2200	2500	3500
L1	820 nH	220 nH	68 nH	27 nH	22 nH	18 nH	15 nH
C2, C3	.018 uF	1000 pF	100 pF	68 pF	68 pF	56 pF	39 pF

Bias Resistor Values for Various Supply Voltages

V _{SUPPLY} (V)	5	6	7	8	9	10	12
R1	24 Ω	47 Ω	68 Ω	91 Ω	110 Ω	130 Ω	180 Ω
Component Size	0805	1206	1210	1210	1210	2010	2010

Typical Performance – TQP369180-PCB

Test conditions unless otherwise noted: $V_{SUPPLY} = +5\text{ V}$, $R_1 = 24\ \Omega$, $I_{CC} = 45\text{ mA}$, $T_{CASE} = +25^\circ\text{C}$

Parameter	Typical Value										Units
Frequency	500	900	1900	2100	2600	3500	4000	5000	6000		MHz
Gain	15.7	15.5	15.0	14.9	14.8	15.2	15.1	14.6	14.2		dB
Input Return Loss	-15.8	-20.9	-20.1	-18.0	-14.1	-18.1	-16.4	-16.2	-15.9		dB
Output Return Loss	-15.9	-25.0	-17.8	-15.9	-12.9	-16.2	-14.4	-12.9	-11.1		dB
Output P1dB	+15.3	+15.2	+14.4	+14.1	+13.8	13.75	12.6	11	9.4		dBm
OIP3	+30.2	+29.8	+29.5	+28.1	+26.8	26.1	24.6	22	20.5		dBm
Noise Figure	3.6	3.6	3.6	3.7	3.8	4	4.1	4.2	4.5		dB

Notes:

- OIP3 measured with two tones at an output power of 0 dBm / tone separated by 1 MHz.

Performance Plots – TQP369180-PCB

Test conditions unless otherwise noted: $V_{SUPPLY} = +5\text{ V}$, $R_1 = 24\ \Omega$, $I_{CC} = 45\text{ mA}$, $T_{CASE} = +25^\circ\text{C}$

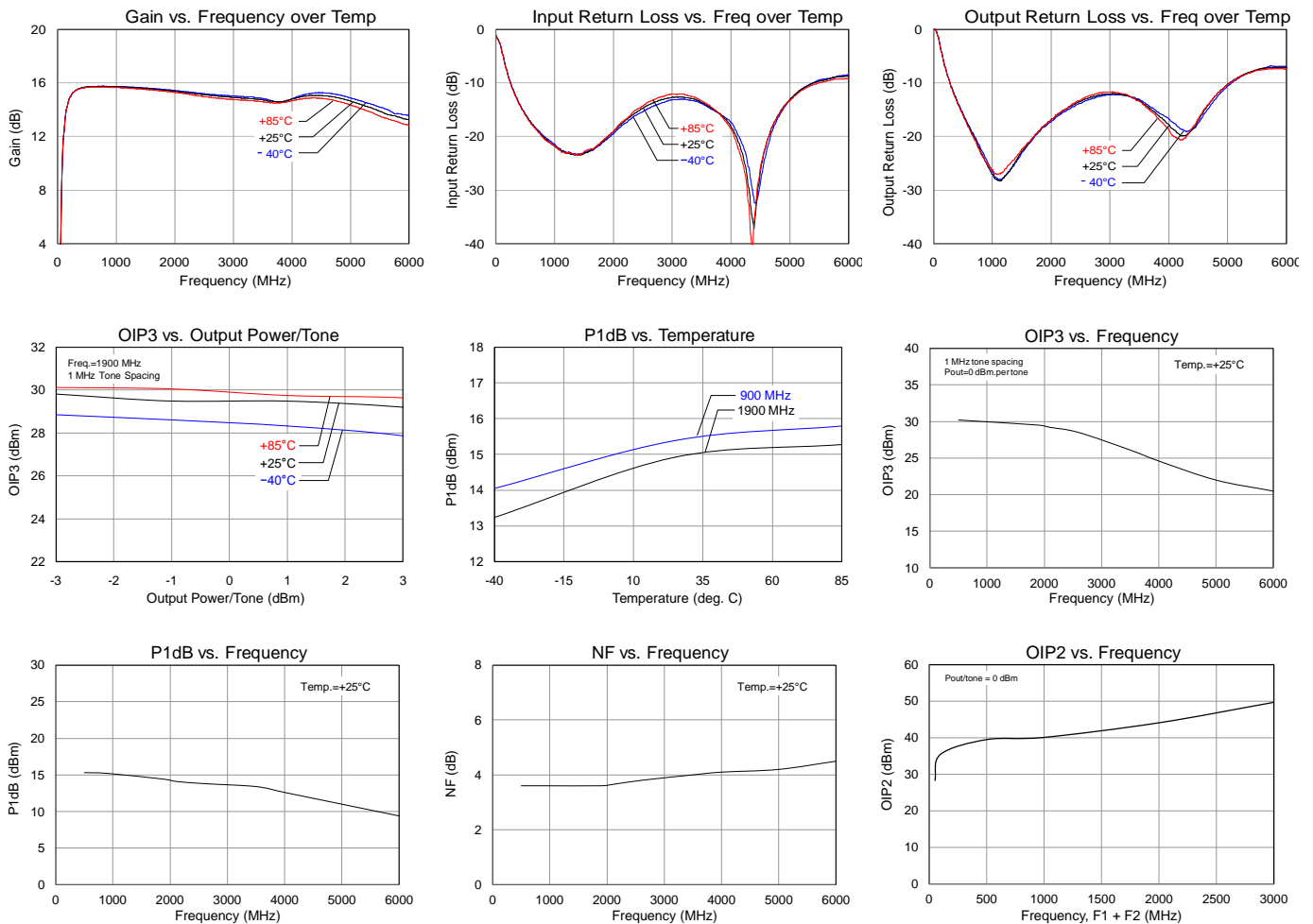

Pin Configuration and Description

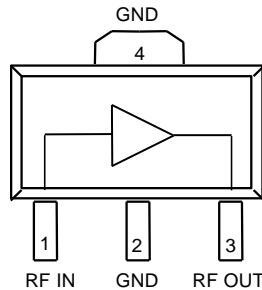

Pin No.	Label	Description
1	RF IN	RF input, matched to 50 ohms. External DC Block is required.
3	RF OUT	RF output / DC supply, matched to 50 ohms. External DC Block, bias choke, and dropping resistor is required.
2, 4, Backside Paddle	GND Paddle	RF/DC ground. Use recommended via pattern to minimize inductance and thermal resistance. See PCB Mounting Pattern for suggested footprint.

Evaluation Board PCB Information

Qorvo PCB 1075825 Material and Stack-up

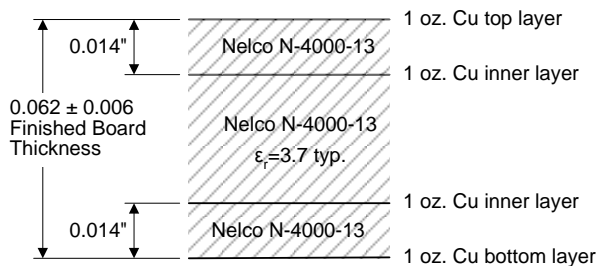

50 Ohm Line Dimensions: Width=0.028"
Spacing=0.028"

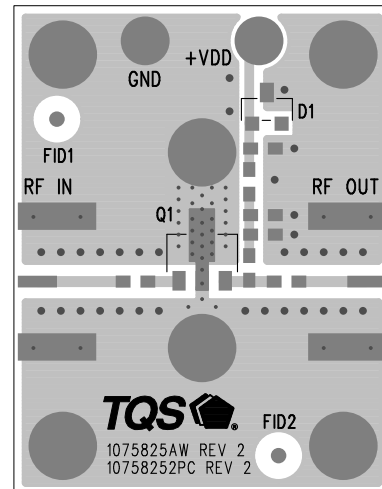

Package Marking and Dimensions

Marking: Part number – 369180
Lot code – XXXX

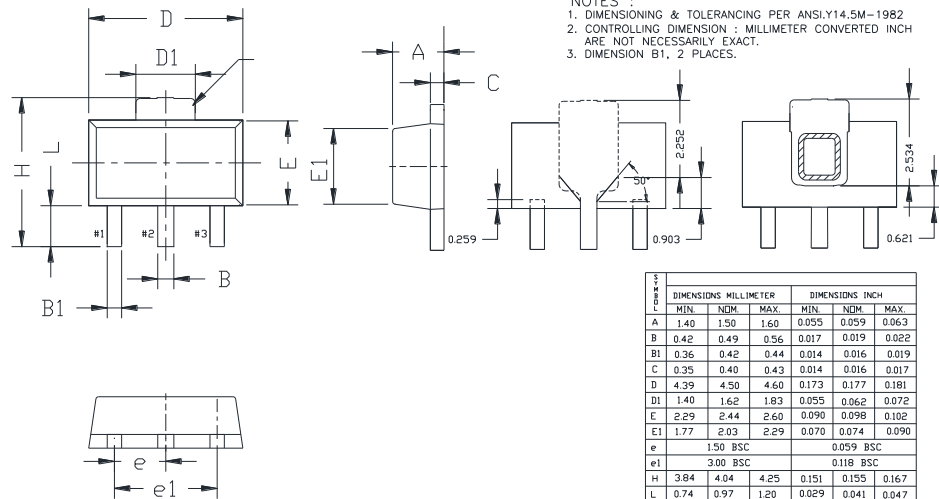

Notes:

1. All dimensions are in millimeters. Angles are in degrees.
2. Dimension and tolerance formats conform to ASME Y14.4M-1994.
3. The terminal #1 identifier and terminal numbering conform to JESD 95-1 SPP-012.
4. Contact plating: NiPdAu or Matte Tin

PCB Mounting Pattern

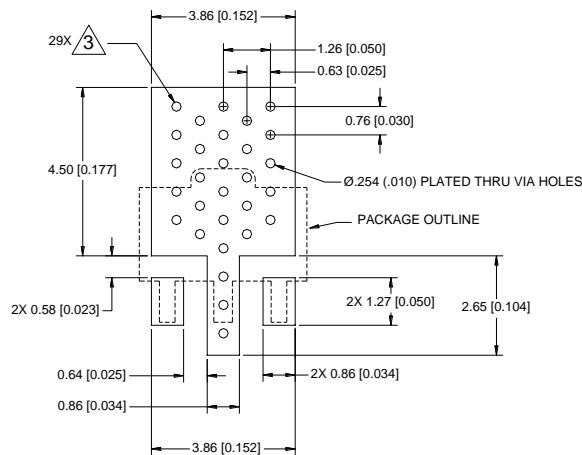

Notes:

1. All dimensions are in millimeters. Angles are in degrees.
2. Use 1 oz. copper minimum for top and bottom layer metal.
3. Vias are required under the backside paddle of this device for proper RF/DC grounding and thermal dissipation.
4. Do not remove or minimize via hole structure in the PCB. Thermal and RF grounding is critical.
5. We recommend a 0.35mm (#80/.0135") diameter bit for drilling via holes and a final plated thru diameter of 0.25 mm (0.10").
6. Ensure good package backside paddle solder attach for reliable operation and best electrical performance.

Product Compliance Information

ESD Sensitivity Ratings



Caution! ESD-Sensitive Device

ESD Rating: Class 1C
Value: ≥ 1000 V and < 2000 V
Test: Human Body Model (HBM)
Standard: JEDEC Standard JESD22-A114

ESD Rating: Class C3
Value: ≥ 1000 V
Test: Charged Device Model (CDM)
Standard: JEDEC Standard JESD22-C101

MSL Rating

MSL Rating: Level 3 or better
Test: 260°C convection reflow
Standard: JEDEC Standard IPC/JEDEC J-STD-020

Solderability

Compatible with both lead-free (260°C maximum reflow temperature) and tin/lead (245°C maximum reflow temperature) soldering processes.

Contact plating: NiPdAu or Matte Tin

RoHS Compliance

This part is compliant with EU 2002/95/EC RoHS directive (Restrictions on the Use of Certain Hazardous Substances in Electrical and Electronic Equipment).

This product also has the following attributes:

- Lead Free
- Halogen Free (Chlorine, Bromine)
- Antimony Free
- TBBP-A ($\text{C}_{15}\text{H}_{12}\text{Br}_4\text{O}_2$) Free
- PFOS Free
- SVHC Free

Contact Information

For the latest specifications, additional product information, worldwide sales and distribution locations:

Tel: 1-844-890-8163

Web: www.qorvo.com

Email: customer.support@qorvo.com

For technical questions and application information: Email: appsupport@qorvo.com

Important Notice

The information contained herein is believed to be reliable; however, Qorvo makes no warranties regarding the information contained herein and assumes no responsibility or liability whatsoever for the use of the information contained herein. All information contained herein is subject to change without notice. Customers should obtain and verify the latest relevant information before placing orders for Qorvo products. The information contained herein or any use of such information does not grant, explicitly or implicitly, to any party any patent rights, licenses, or any other intellectual property rights, whether with regard to such information itself or anything described by such information. **THIS INFORMATION DOES NOT CONSTITUTE A WARRANTY WITH RESPECT TO THE PRODUCTS DESCRIBED HEREIN, AND QORVO HEREBY DISCLAIMS ANY AND ALL WARRANTIES WITH RESPECT TO SUCH PRODUCTS WHETHER EXPRESS OR IMPLIED BY LAW, COURSE OF DEALING, COURSE OF PERFORMANCE, USAGE OF TRADE OR OTHERWISE, INCLUDING THE IMPLIED WARRANTIES OF MERCHANTABILITY AND FITNESS FOR A PARTICULAR PURPOSE.**

Without limiting the generality of the foregoing, Qorvo products are not warranted or authorized for use as critical components in medical, life-saving, or life-sustaining applications, or other applications where a failure would reasonably be expected to cause severe personal injury or death.

Copyright 2017 © Qorvo, Inc. | Qorvo is a registered trademark of Qorvo, Inc.